

Hallmark Industries, Inc. - PM DC MOTORS

Part Number: **MD1415B**

Description: PM DC SCR Type, 1.5 HP, 180V, TEFC, 145TC w/Removable Base

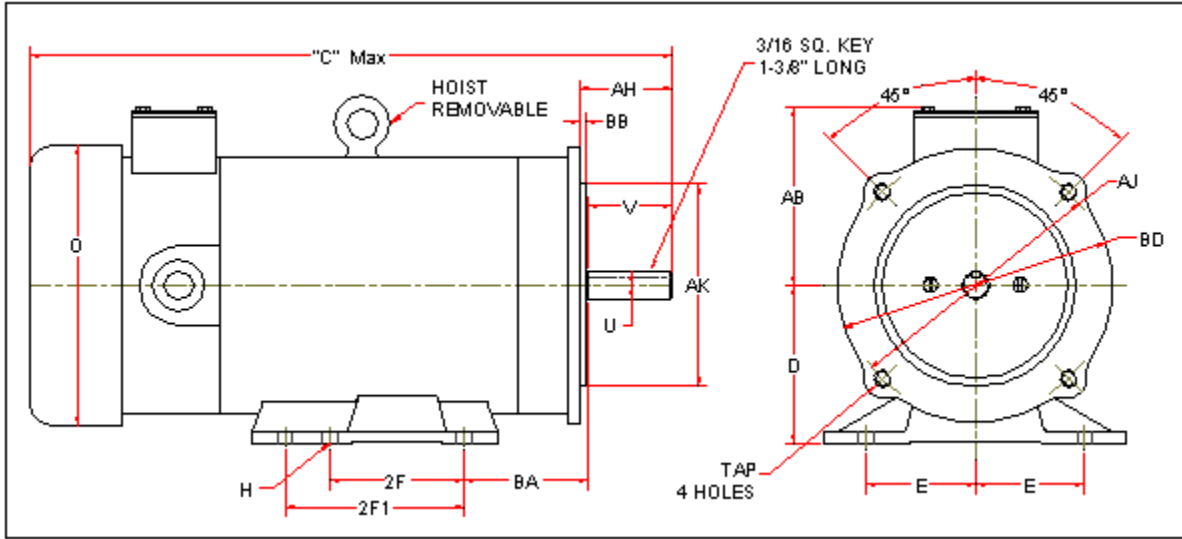

D	E	2F	2F1	H	O	U	V	AB	AH	AJ	AK	BA	BB	BD	TAP	C
3-1/2	2-3/4	4	5	11/32	6.69	0.875	2.25	4.50	2-1/8	5.875	4.500	2.750	0.125	6.30	.375-16	14.7

Part #	H.P.	Base RPM	Arm. Volt.	NEMA Frame	Encl.	F.L Amps	INSUL.	F.F.	Torque	Serv. Factor	App. Wgt.
MD1415B	1.5	1750	180 VDC	145TC	TEFC	7.8	F	1.35	54 in.lbs	1.0	52 lbs