

Hallmark Industries, Inc. - PM DC MOTORS

Part Number: **MD0507A**

Description: PM DC, SCR Type, 3/4 HP, 90V, TEFC, 56C w/Removable Base

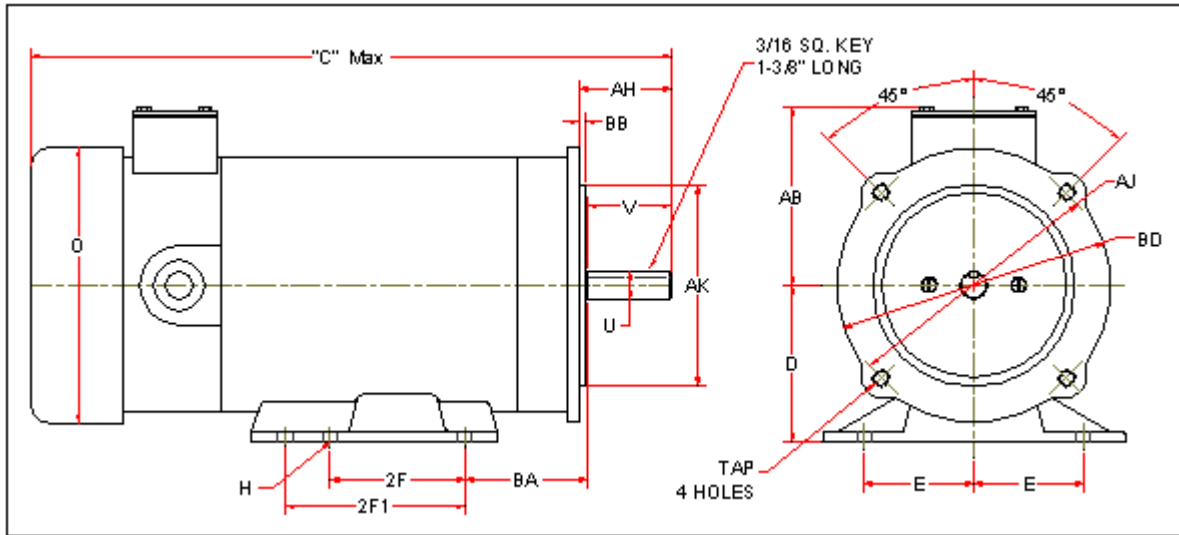

D	E	2F	H	O	U	V	AB	AH	AJ	AK	BA	BB	BD	TAP	C
3-1/2	2-7/16	3.00	11/32 SLOT	5.57	0.625	1.875	4-1/8	2-1/16	5.875	4.500	2.750	0.125	6.14	.375-16	14.0

Part #	H.P.	Base RPM	Arm. Volt.	NEMA Frame	Encl.	F.L Amps	INSUL.	F.F.	Torque	Serv. Factor	App. Wgt.
MD0507A	3/4	1750	90 VDC	56C	TEFC	7.8	F	1.35	27 in.lbs	1.0	29 lbs