

Hallmark Industries, Inc. - PM DC MOTORS

Part Number: **MD0502F**

Description: PM DC, 1/4 HP, 24V, TEFC, 56C w/Removable Base

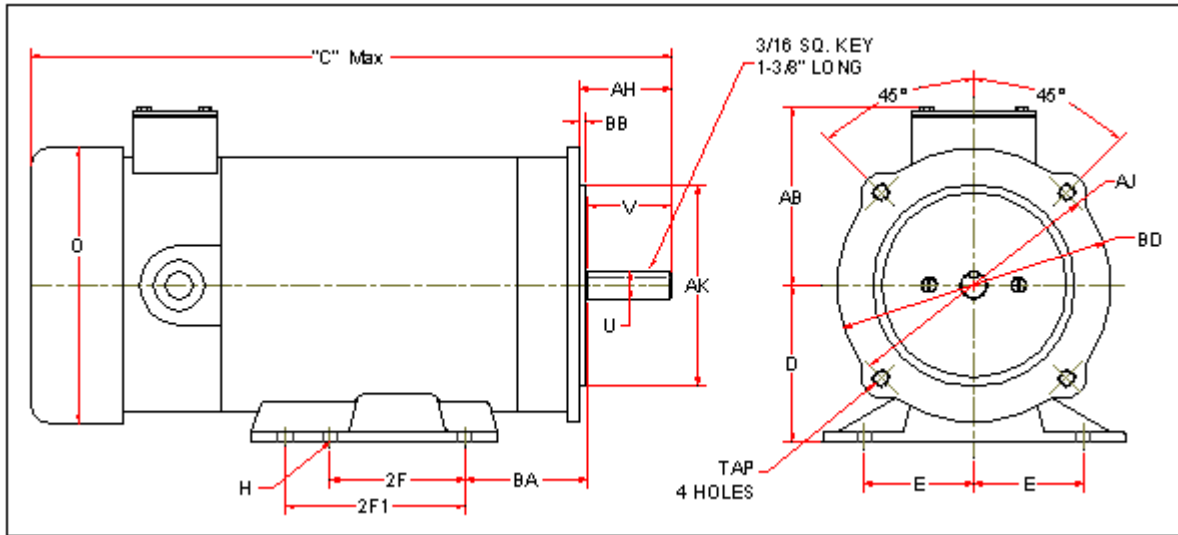

D	E	2F	H	O	U	V	AB	AH	AJ	AK	BA	BB	BD	TAP	C
3-1/2	2-7/16	3.00	11/32 SLOT	5.57	0.625	1.875	4-1/8	2-1/16	5.875	4.500	2.750	0.125	6.14	.375-16	11.6

H.P.	Base RPM	Arm. Volt.	NEMA Frame	Encl.	F.L Amps	INSUL.	Torque	Serv. Factor	App. Wgt.
1/4	1750	24 VDC	56C	TEFC	16	F	9 in.lbs	1.0	20 lbs