

Hallmark Industries, Inc. - PM DC MOTORS

Part Number: **MD0402C**

Description: PMDC, SCR Type, 1/4 HP, 90V, TENV, 48C w/Removable Base

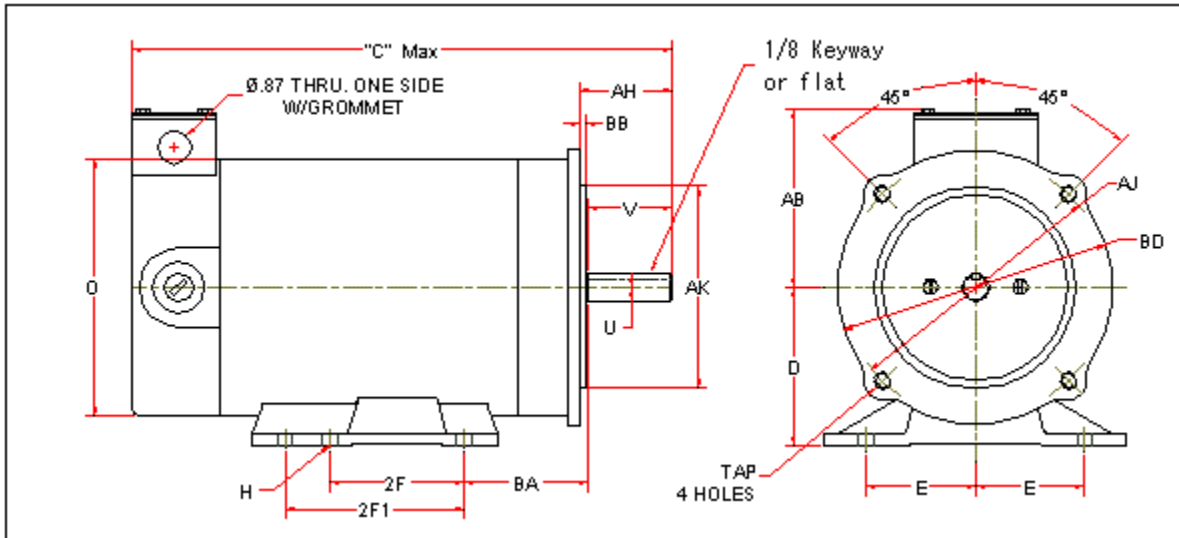

D	E	2F	H	O	U	V	AB	AH	AJ	AK	BA	BB	BD	TAP	C
3	2-1/8	2.75	11/42 SLOT	4.45	0.5	1.5	3.6	1.68	3.75	3	2.50	0.12	4.54	1/4-20 UNC	9.21

Part #	H.P.	Base RPM	Arm. Volt.	NEMA Frame	Encl.	F.L Amps	INSUL.	F.F.	Torque	Serv. Factor	App. Wgt.
MD0402C	1/4	1750	90 VDC	48C	TENV	2.9	F	1.35	12 in.lbs	1.0	18 lbs